

Theoretical Physics

Prof. Ruiz, UNC Asheville, doctorphys on YouTube

Chapter H Notes. Statistical Mechanics

H1. Combinatorics. There are 5 people in a family. They are given two tickets to the movies. How many different ways can the family decide on the 2 people to go to the movies? The answer is below. Note that we divide by 2 since the order does not count as the two family members get into the car to go to the movies.



$$\frac{5 \cdot 4}{2 \cdot 1} = \frac{5!}{2!3!} = \frac{N!}{n_1!n_2!}$$

Blaise Pascal (1623-1662)

Courtesy School of Mathematics and Statistics
University of St. Andrews, Scotland

The Pascal Triangle provides a prescription for determining the binomial coefficients in $(a+b)^n$, which coefficients are relevant to our question above. What is the pattern?

$$(a+b)^n = a^n + na^{n-1}b + \frac{n(n-1)}{1 \cdot 2} a^{n-2}b^2 \dots + c(n,r)a^{n-r}b^r \dots + b^n$$

$$c(n,r) = \frac{n(n-1)(n-2)\dots(n-r+1)}{1 \cdot 2 \cdot 3 \cdot \dots \cdot r} = \frac{n!}{r!(n-r)!} \equiv \binom{n}{r}$$

The Pascal Triangle

$$\begin{array}{cccccccc} & & & & 1 & & & & \\ & & & & 1 & & 1 & & \\ & & & 1 & 2 & 1 & & & \\ & & 1 & 3 & 3 & 1 & & & \\ & 1 & 4 & 6 & 4 & 1 & & & \\ & 1 & 5 & 10 & 10 & 5 & 1 & & \\ 1 & 1 & 6 & 15 & 20 & 15 & 6 & 1 & \\ 1 & 7 & 21 & 35 & 35 & 21 & 7 & 1 & \end{array}$$

Courtesy Wikimedia

H2. The Statistical Problem and Stirling's Approximation. We are interested in the problem of placing n_1 particles in energy state ε_1 , n_2 particles in energy state ε_2 , and so on. How many ways Ω can you do this? The answer is

$$\Omega = \frac{N!}{n_1!n_2!n_3!\dots}$$

where we have the conditions

$$N = n_1 + n_2 + n_3 + \dots \text{ for the total number of particles and}$$

$$E = n_1\varepsilon_1 + n_2\varepsilon_2 + n_3\varepsilon_3 + \dots \text{ for the total energy.}$$

The problem is this. We would like to maximize Ω given the constraints that the total number of particles N is held constant and the total energy E is constant. The form for Ω looks intimidating. But if we maximize the natural logarithm of Ω , that will have the same result. So we look at

$$\ln \Omega = \ln N! - \ln n_1! - \ln n_2! - \dots$$

This looks friendlier as we have a sum instead of products. But we still do not like factorials. Note this trick



$$\ln n! = \ln 1 + \ln 2 + \dots + \ln n$$

The factorial is replaced by a sum. But there is still more simplification for large n .

This brings us to the mathematician Stirling and his approximation for large n . It is

$$n! \approx \sqrt{2\pi n} \left[\frac{n}{e} \right]^n = n^n e^{-n} \sqrt{2\pi n}$$

We will derive a variant of this approximation.

Sir James Stirling (1692-1770)

Painting by Sir Peter Lely

Courtesy Wikigallery.org.

We return to

$$\ln n! = \ln 1 + \ln 2 + \dots + \ln n$$

and check out the plot below.

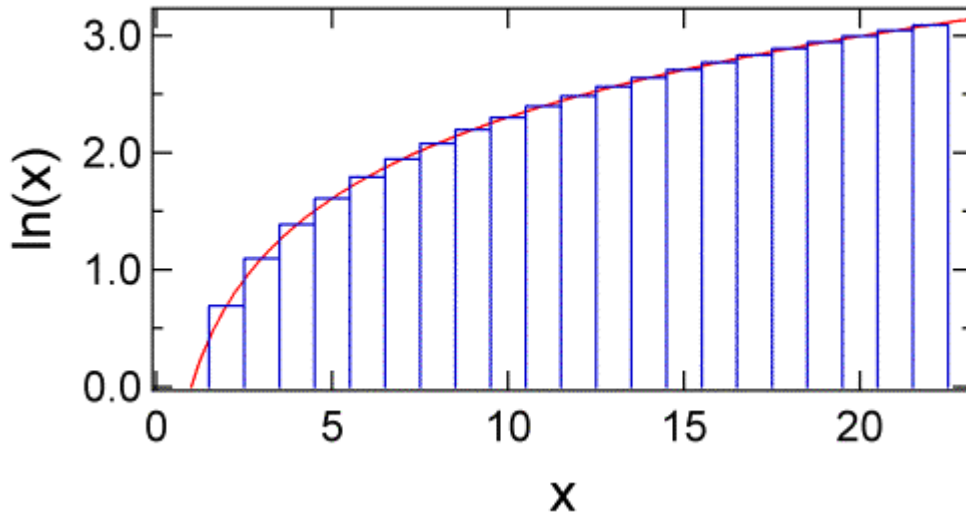

Courtesy UC Davis ChemWiki by University of California, Davis

We can approximate this by the areas of the strips where the width of each strip is 1.

$$\ln n! = (\ln 1)(1) + (\ln 2)(1) + \dots + (\ln n)(1)$$

But this is the integral $\int_1^n \ln x dx$ to a very good approximation. This integral can be done by a cute trick we can arrive at from looking at these derivatives.

$$\frac{d \ln x}{dx} = \frac{1}{x} \quad \frac{dx}{dx} = 1 \quad \frac{d(x \ln x)}{dx} = \ln x + x \frac{1}{x} = \ln x + 1$$

Then $\frac{d(x \ln x - x)}{dx} = \ln x$ and our integral is $\int_1^n \ln x dx = (x \ln x - x) \Big|_1^n$

and

$$\int_1^n \ln x dx = (x \ln x - x) \Big|_1^n = (n \ln n - n) - (1 \ln 1 - 1) = n \ln n - n + 1$$

For large n we have

$$\ln n! \approx \int_1^n \ln x dx \approx n \ln n - n$$

If we go back to the Stirling formula

$$n! \approx \sqrt{2\pi n} \left[\frac{n}{e} \right]^n = n^n e^{-n} \sqrt{2\pi n}$$

Then

$$\ln n! \approx \ln(n^n e^{-n} \sqrt{2\pi n}) = n \ln n - n \ln e + \frac{1}{2} (\ln 2 + \ln \pi + \ln n)$$

$$\ln n! \approx \ln(n^n e^{-n} \sqrt{2\pi n}) = n \ln n - n + \frac{1}{2} (\ln 2 + \ln \pi + \ln n)$$

Our approximation includes the first two terms, which are larger than the last group. The only one in this group you might be concerned with is $\ln n$ but $n \ln n$ easily wins as being far greater when n is large. So, we will be using our version of the Stirling approximation is

$$\ln n! \approx n \ln n - n$$

Are you still worried? Then, let's use a calculator and pick a small number compared to zillions of particles in different energy levels. How about n = 10?

$$\ln 10! = \ln 3,628,800 = 15.1$$

$$n \ln n - n = 10 \ln 10 - 10 = 10 \cdot 2.30 - 10 = 13.0$$

For n = 50

$$\ln 50! = 148.48$$

$$n \ln n - n = 50 \ln 50 - 50 = 50 \cdot 3.91 - 50 = 145.6$$

Our problem restated:

Maximize:

$$\ln \Omega = \ln N! - \ln n_1! - \ln n_2! - \dots \text{ with the constraints}$$

$$N = n_1 + n_2 + n_3 + \dots \text{ for the total number of particles and}$$

$$E = n_1 \varepsilon_1 + n_2 \varepsilon_2 + n_3 \varepsilon_3 + \dots \text{ for the total energy.}$$

With Stirling: $\ln n! \approx n \ln n - n$, we need to maximize

$$\ln \Omega = N \ln N - N - (n_1 \ln n_1 - n_1) - (n_2 \ln n_2 - n_2) - \dots$$

Note that

$$-N - (-n_1 - n_2 - \dots) = -N - (-N) = 0$$

So we have

$$\ln \Omega = N \ln N - n_1 \ln n_1 - n_2 \ln n_2 - \dots$$

PH1 (Practice Problem). Find the number of ways that nine people at a picnic can be split into the following categories of activities: two of the nine are walking in the woods, three are talking at the picnic table, and four are playing a lawn game.

PH2 (Practice Problem). Find the number of ways that nine particles can be in the following energy levels: two of the nine are in energy level $\varepsilon_1 = \varepsilon$, three are in energy level $\varepsilon_2 = 2\varepsilon$, and four are in energy level $\varepsilon_3 = 3\varepsilon$. What is the total energy for this system of twelve particles? What is the average energy per particle?

H3. The Method of Undetermined Multipliers. We will need this method, which we introduce through practice problems.

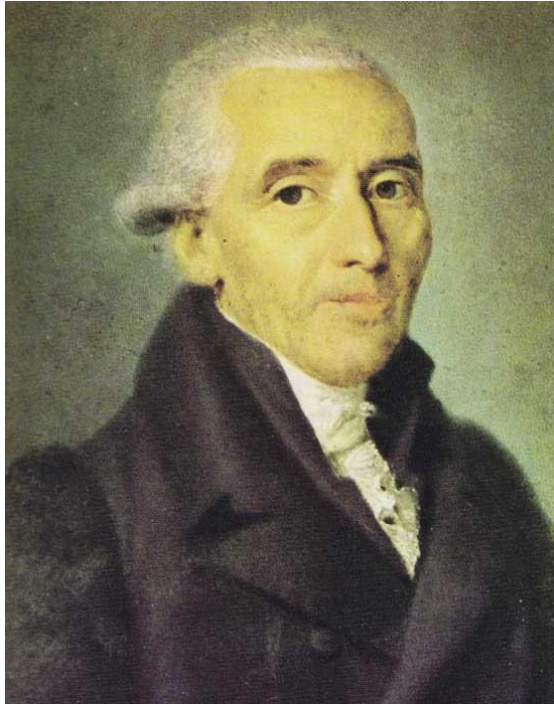

Joseph-Louis Lagrange (1736-1813)

Courtesy www.scientific-web.com

PH3 (Practice Problem). Before using the Lagrange Method of Undetermined Multipliers, let's first do a max-min problem using the standard approach. Find the largest area you can enclose with a fixed amount of fence given by $L = 2x + 2y$.

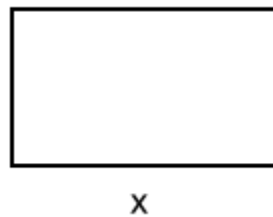

Let $A = A(x,y)$. Then find A as $A(x)$ only and set $dA/dx = 0$. Solve for x . You will get two solutions: $x = 0$

and $x = L/4$. The second one is your square with $x = y = L/4$ as expected.

PH4 (Practice Problem). Maximize the Area using the Lagrange Method of Undetermined Multipliers. You will do the same problem now by considering

$$dA(x, y) = \frac{\partial A}{\partial x} dx + \frac{\partial A}{\partial y} dy = 0$$

If the dx and dy were independent, we could set each partial to zero. In the standard approach you get rid of the y and write an equation where the derivative of A with respect to x is set to zero. Here is another way. Use

$$dA(x, y) - \lambda dL = 0 \text{ and } \left[\frac{\partial A}{\partial x} - \lambda \frac{\partial L}{\partial x} \right] dx + \left[\frac{\partial A}{\partial y} - \lambda \frac{\partial L}{\partial y} \right] dy = 0 .$$

Though dx and dy are not independent, we pick λ so

$$\frac{\partial A}{\partial y} - \lambda \frac{\partial L}{\partial y} = 0$$

Since the dx can be thought of as an arbitrary differential, we have

$$\frac{\partial A}{\partial x} - \lambda \frac{\partial L}{\partial x} = 0$$

The beauty of the method is we can write the pair

$$\frac{\partial A}{\partial x} - \lambda \frac{\partial L}{\partial x} = 0 \quad \text{and} \quad \frac{\partial A}{\partial y} - \lambda \frac{\partial L}{\partial y} = 0.$$

The price we pay is that we introduced λ , which must be found. But that is worth the deal. Use

$$A = xy \quad \text{and} \quad L = 2x + 2y$$

To finish this problem. You will find $x = y = 2\lambda$.

H4. Maximize Ω . Here is our challenge. What is the most probable arrangement of n_i particles in each of the various energy levels ε_i . We want to maximize

$$\ln \Omega = \ln \left[\frac{N!}{n_1! n_2! n_3! \dots} \right] \approx N \ln N - n_1 \ln n_1 - n_2 \ln n_2 - \dots$$

where we have the constraints

$$N = n_1 + n_2 + n_3 + \dots \quad \text{for the total number of particles and}$$

$$E = n_1 \varepsilon_1 + n_2 \varepsilon_2 + n_3 \varepsilon_3 + \dots \quad \text{for the total energy.}$$

We can't proceed to do a max-min problem by considering all the dn_i independent because they are not. The two constraints fix two of them as the others are free to vary. So we cannot start with

$$d(\ln \Omega) = \frac{\partial(\ln \Omega)}{\partial n_1} dn_1 + \frac{\partial(\ln \Omega)}{\partial n_2} dn_2 + \frac{\partial(\ln \Omega)}{\partial n_3} dn_3 + \dots = 0$$

This problem is due to our two constraints. Our first constraint involves the total number.

$$dN = dn_1 + dn_2 + dn_3 + \dots = 0 .$$

If we start varying the n_i , the last one is determined since the sum of the numbers must be N . Our other constraint is

$$dE = \varepsilon_1 dn_1 + \varepsilon_2 dn_2 + \varepsilon_3 dn_3 + \dots = 0 .$$

However, we can introduce two undetermined multipliers α and β and write

$$d(\ln \Omega) - \alpha dN - \beta dE = 0 ,$$

$$\sum_i \left[\frac{\partial(\ln \Omega)}{\partial n_i} - \alpha \frac{\partial N}{\partial n_i} - \beta \frac{\partial E}{\partial n_i} \right] dn_i = 0 .$$

We choose the undetermined multipliers to “kill” the two dn_i that are constrained. The price we pay is that we will have to solve for these undetermined multipliers at some point. We can then state for all the n_i

$$\frac{\partial(\ln \Omega)}{\partial n_i} - \alpha \frac{\partial N}{\partial n_i} - \beta \frac{\partial E}{\partial n_i} = 0 .$$

First find $\frac{\partial(\ln \Omega)}{\partial n_1} = \frac{\partial}{\partial n_1} (N \ln N - n_1 \ln n_1 - n_2 \ln n_2 - \dots) .$

The only nonzero partial derivative will be this one.

$$\frac{\partial(\ln \Omega)}{\partial n_1} = \frac{\partial}{\partial n_1} (N \ln N - n_1 \ln n_1)$$

Note that $\frac{\partial}{\partial n_1} (N \ln N) = \frac{\partial}{\partial N} (N \ln N) \frac{\partial N}{\partial n_1} = (\ln N + \frac{N}{N})(1) .$ giving

$$\frac{\partial}{\partial n_1} (N \ln N) = \ln N + 1$$

The other partial derivative we need is

$$\frac{\partial}{\partial n_1} (n_1 \ln n_1) = \ln n_1 + 1$$

We use these to find our original partial derivative.

$$\frac{\partial(\ln \Omega)}{\partial n_1} = \frac{\partial}{\partial n_1} (N \ln N - n_1 \ln n_1) = \frac{\partial}{\partial n_1} (N \ln N) - \frac{\partial}{\partial n_1} (n_1 \ln n_1)$$

$$\frac{\partial(\ln \Omega)}{\partial n_1} = (\ln N + 1) - (\ln n_1 + 1) = \ln N - \ln n_1.$$

Then for

$$\frac{\partial(\ln \Omega)}{\partial n_1} - \alpha \frac{\partial N}{\partial n_1} - \beta \frac{\partial E}{\partial n_1} = 0$$

We have the needed pieces

$$\frac{\partial(\ln \Omega)}{\partial n_1} = \ln N - \ln n_1$$

$$\frac{\partial N}{\partial n_1} = 1 \quad \text{from } N = n_1 + n_2 + n_3 + \dots$$

$$\frac{\partial E}{\partial n_1} = \varepsilon_1 \quad \text{from } E = n_1 \varepsilon_1 + n_2 \varepsilon_2 + n_3 \varepsilon_3 + \dots$$

Summary:

$$\frac{\partial(\ln \Omega)}{\partial n_1} - \alpha \frac{\partial N}{\partial n_1} - \beta \frac{\partial E}{\partial n_1} = 0$$

$$\frac{\partial(\ln \Omega)}{\partial n_1} = \ln N - \ln n_1$$

$$\frac{\partial N}{\partial n_1} = 1$$

$$\frac{\partial E}{\partial n_1} = \varepsilon_1$$

We get for $\frac{\partial(\ln \Omega)}{\partial n_1} - \alpha \frac{\partial N}{\partial n_1} - \beta \frac{\partial E}{\partial n_1} = 0$, the equation

$$\ln N - \ln n_1 - \alpha - \beta \varepsilon_1 = 0.$$

From this,

$$\ln n_1 - \ln N = -\alpha - \beta \varepsilon_1$$

$$\ln \frac{n_1}{N} = -\alpha - \beta \varepsilon_1$$

$$\frac{n_1}{N} = e^{-\alpha - \beta \varepsilon_1}$$

$$n_1 = N e^{-\alpha - \beta \varepsilon_1}$$

We can do this for any n_i so we replace the subscript 1 with i : $n_i = N e^{-\alpha - \beta \varepsilon_i}$

H5. Evaluating the Undetermined Multipliers α and β .

$$n_i = Ne^{-\alpha - \beta \epsilon_i}$$

1. Evaluating α

$$N = n_1 + n_2 + \dots = Ne^{-\alpha - \beta \epsilon_1} + Ne^{-\alpha - \beta \epsilon_2} \dots, \text{ i.e.,}$$

$$N = N \sum_i e^{-\alpha - \beta \epsilon_i}$$

$$N = e^{-\alpha} N \sum_i e^{-\beta \epsilon_i}$$

$$1 = e^{-\alpha} \sum_i e^{-\beta \epsilon_i}$$

$$e^{-\alpha} = \frac{1}{\sum_i e^{-\beta \epsilon_i}} \equiv \frac{1}{Z}$$

The denominator is called the partition function Z . Then $n_i = Ne^{-\alpha - \beta \epsilon_i}$ can be written as shown below.

$$n_i = N \frac{e^{-\beta \epsilon_i}}{Z} \quad Z = \sum_i e^{-\beta \epsilon_i} = e^{-\beta \epsilon_1} + e^{-\beta \epsilon_2} + \dots$$

2. Evaluating β . We meet up with Pascal again. He was a super interdisciplinary guy: a mathematician, a physicist, and philosopher. We see him in this section as a physicist. One of the things he is known for in philosophy is "The Wager," where he does a probability analysis to convince others that it pays off to believe in God.



Blaise Pascal (1623-1662). Pascal's Law.
 Courtesy School of Mathematics and Statistics
 University of St. Andrews, Scotland

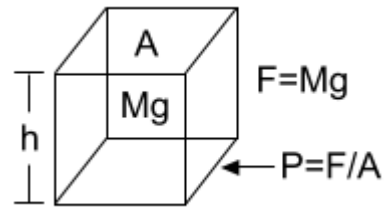

$$P = \frac{F}{A} = \frac{Mg}{A} = \frac{\rho Vg}{A} = \frac{\rho Ahg}{A} = \rho gh$$

Pascal's Law gives the pressure due to the weight of a fluid or gas at a depth h .

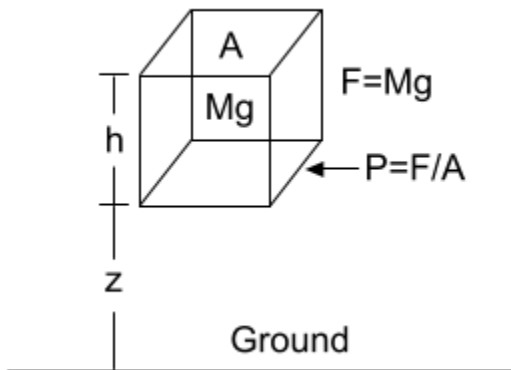

Consider measuring from the ground up so that

$$z + h = H,$$

a constant. Then,

$$dz + dh = 0$$

$$dh = -dz$$

We would like to measure from the ground up rather than from a fixed point high in the sky at a distance H up. Then,

$$P = \rho gh \quad \text{and} \quad dP = \rho g dh = -\rho g dz$$

Using the ideal gas law $PV = NkT$, we can write $P = NkT / V$.

In summary, we have

$$P = \rho gh \quad dP = -\rho g dz \quad P = \frac{NkT}{V}$$

Let m be the mass of one particle in the gas. Then

$$Pm = \frac{NmkT}{V} = \left[\frac{Nm}{V} \right] kT = \rho kT .$$

For a gas at constant temperature we only worry about a change in density due to the height.

$$dP = \frac{kT}{m} d\rho$$

Putting together the pieces $dP = -\rho g dz$ and $dP = \frac{kT}{m} d\rho$ we obtain

$$\frac{kT}{m} d\rho = -\rho g dz$$

$$\frac{d\rho}{\rho} = -\frac{mg}{kT} dz \quad \text{and} \quad \int_{\rho_0}^{\rho} \frac{1}{\rho} d\rho = -\frac{mg}{kT} \int_0^z dz$$

$$\ln \rho \Big|_{\rho_0}^{\rho} = -\frac{mg}{kT} z \Big|_0^z, \text{ which leads to } \ln \frac{\rho}{\rho_0} = -\frac{mg}{kT} z \text{ and finally}$$

$$\rho = \rho_0 e^{-\frac{mgz}{kT}} .$$

Since $\mathcal{E} = mgz$ (potential energy), then our β in $n_i = N \frac{e^{-\beta \mathcal{E}_i}}{Z}$ must be

$$\beta = \frac{1}{kT} .$$

H6. Entropy.

$$\Delta U = \Delta Q - \Delta W$$

Since heat and work depend on path, one often writes the differentials with a slash, usually through the top. See the slash below in the heat and work terms.

$$dU = dQ - dW$$

But we can fix the work to obtain a good differential so that when integrated, we are path independent. The result is the change in volume. Take any path you want with this set up below and we get a "perfect" differential, namely, delta V.

$$\frac{\Delta W}{P} = \Delta V$$

Now the delta does NOT depend on path. It is simply the change in volume. Can we fix Q? Yes. Consider

$$\Delta Q = \Delta U + P\Delta V$$

Use the ideal gas law.

$$PV = nRT \quad \text{and} \quad \Delta U = \frac{3}{2}nR\Delta T$$

$$\Delta Q = \Delta U + P\Delta V = \frac{3}{2}nR\Delta T + \frac{nRT}{V}\Delta V$$

$$\frac{\Delta Q}{T} = \frac{\Delta U}{T} + \frac{P\Delta V}{T} = \frac{3}{2}\frac{nR\Delta T}{T} + \frac{nR}{V}\Delta V$$

We can integrate this and get an answer that is path independent. The fixed arrangement introduces a new variable S called the entropy:

$$\frac{\Delta Q}{T} = \Delta S$$

PH5 (Practice Problem). Integrate the above to show for the ideal gas that the entropy change is

$$S_2 - S_1 = \frac{3}{2} nR \ln \frac{T_2}{T_1} + nR \ln \frac{V_2}{V_1} .$$

We can now write

$$dU = TdS - PdV \quad \text{since } \Delta S = \Delta Q / T .$$

Note that $\frac{\partial U}{\partial S} = T$

The above is macroscopic where we have properties for the gas as a whole such as temperature, volume, pressure, energy, and entropy.

In our study of statistical mechanics we found

$$d(\ln \Omega) - \alpha dN - \beta dE = 0$$

$$\beta = \frac{1}{kT}$$

$$\beta dE = d(\ln \Omega) - \alpha dN \quad \text{and} \quad dE = \frac{1}{\beta} d(\ln \Omega) - \frac{\alpha}{\beta} dN$$

$$\frac{\partial E}{\partial(\ln \Omega)} = \frac{1}{\beta} = kT$$

Big profound connection coming up since energy E is energy U.

$$\frac{\partial U}{\partial S} = T \quad \text{and} \quad \frac{\partial E}{\partial(\ln \Omega)} = kT \quad \text{leads to} \quad S = k \ln \Omega .$$

The second law of thermodynamics involves the entropy. Since things tend to the most probable, we want the largest Ω and thus the largest $S = k \ln \Omega$.

If you combine two systems with Ω_1 and Ω_2 , then you get a total number of ways, i.e., total number of microstates, given by

$$\Omega = \Omega_1 \Omega_2.$$

This means the entropy adds:

$$S = k \ln \Omega = k \ln(\Omega_1 \Omega_2) = k \ln \Omega_1 + k \ln \Omega_2, \text{ i.e.,}$$

$$S = S_1 + S_2.$$

The second law is sometimes stated as the total entropy of the universe always increases. Another form is that you must waste some energy. Still another variant is that there is no such thing as a perpetual motion machine.

H7. The Laws of Thermodynamics.

First Law: Conservation of Energy

$$\Delta U = \Delta Q - \Delta W$$

Second Law: Total Entropy Increases

$$\Delta S = \Delta Q / T$$



$$\Delta U = T\Delta S - P\Delta V$$

Remember our engines? You put heat in from a higher temperature, do work, and expel heat at a lower temperature. The first law states that $Q_h = W + Q_c$. The second law states that you must waste some of your energy, i.e., you will have $Q_c \neq 0$. The efficiency therefore will always be less than 1:

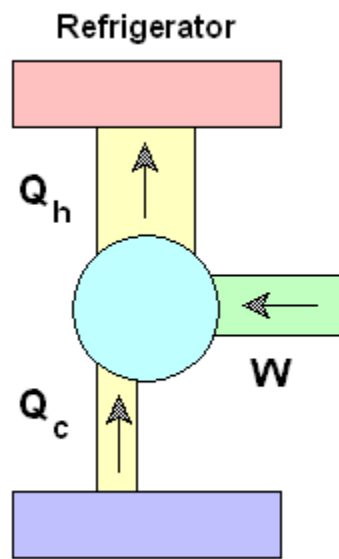
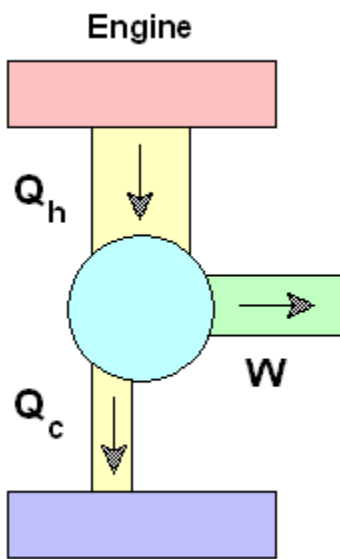

$$\eta = \frac{W}{Q_h}$$

$$\eta = \frac{Q_h - Q_c}{Q_h}$$

$$\eta = 1 - \frac{Q_c}{Q_h} < 1$$